

BTG to 16,6 from 99 kW SERIES

Gas burners



baltur

BTG to 16,6 from 99 kW SERIES

Product range

The main features of BTG series point out that these burners have been developed to meet the requirements of the installer and the final user as well.

BTG burners are suitable both for boilers without back pressure and slightly pressurised boilers.

Safety, reliability, low noise level and utter flame stability are the result of an excellent design, both technical and aesthetic.

The burner is made of light aluminium alloy, with the fan plan perpendicular to the combustion head axis.

It stands out for their compactness and reduced dimensions.

Thanks to the combustion head which can be pulled out without opening the burner, the possible air regulation from the outside (BTG 3 and BTG 20) and easy access to the components (electric motor, fan, ignition

transformer, control box and combustion head) allow an easy and quick installation, regulation and service.

The burner is protected by a plastic cover, which is provided with a hole where from the safety control box switch appears for re-ignition and switch-off purposes.

The diagrams are purely illustrative and refer to tests using test boilers as per current standards and legislation. In practice, there may be considerable differences due to the following factors:

- The capacity of the burner to exceed the overpressure when switched ON (not strictly related to the operating pressure) which varies from boiler to boiler.
- The considerable thermal load of the combustion chamber (ratio between the thermal power of the combustion chamber and the corresponding volume - kcal/h/m³) which means the burner fan might not be operating within the full operating range.

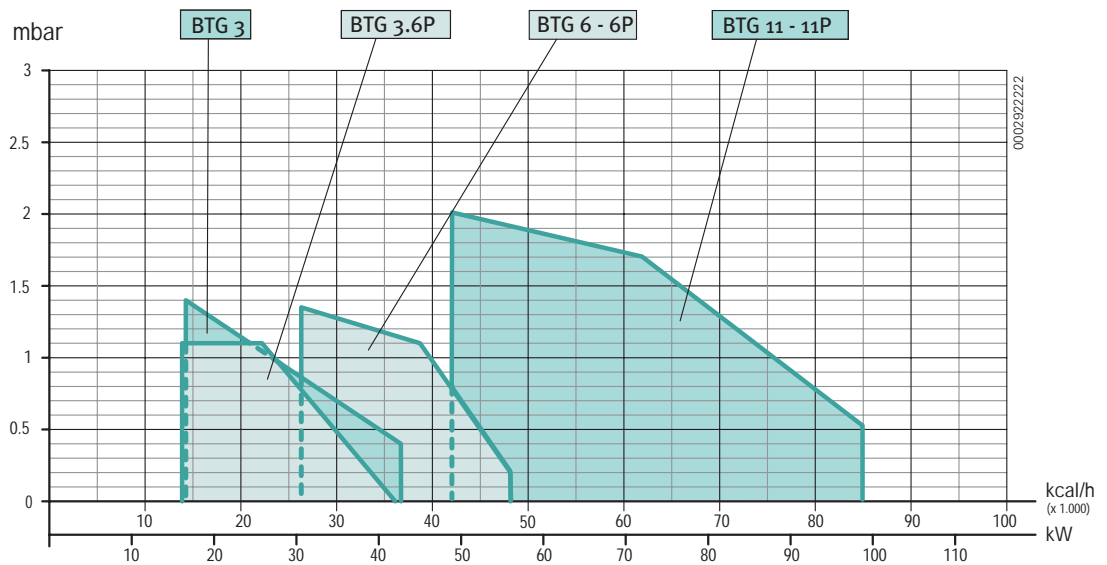

NOTES:

1) Equipped with air shut-off device.

*) Net calorific value of natural gas:
Hi = 35,80 MJ/m³ = 8550 kcal/m³, at reference conditions of 0°C, 1013 mbar.

**) Maximum gas inlet pressure at pressure regulator in CE version, at gas train for EXP version.

Same models are suitable for 60Hz.

Model	Part no.	Heat output		Capacity *)		Pressure natural gas **)		Power supply electric	Motor kW	Notes
		min. kW	max kW	min. m ³ /h	max m ³ /h	CE mbar	EXP mbar			
Single-stage gas burners										
BTG 3	17000010	16,6	42,7	1,7	4,3	65	65	1N AC 50Hz 230V	0,09	1)
BTG 3,6	17020010	16,3	41,9	1,6	4,2	65	65	1N AC 50Hz 230V	0,11	1)
BTG 6	17040010	30,6	56,3	3,1	5,6	360	360	1N AC 50Hz 230V	0,11	1)
BTG 11	17060010	48,8	99,0	4,9	9,9	360	360	1N AC 50Hz 230V	0,11	1)
Two-stage gas burners										
BTG 3,6 P	17030010	16,3	41,9	1,6	4,2	360	360	1N AC 50Hz 230V	0,11	1)
BTG 6 P	17050010	30,6	56,3	3,1	5,6	360	360	1N AC 50Hz 230V	0,11	1)
BTG 11 P	17070010	48,8	99,0	4,9	9,9	360	360	1N AC 50Hz 230V	0,11	1)

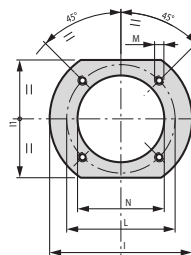
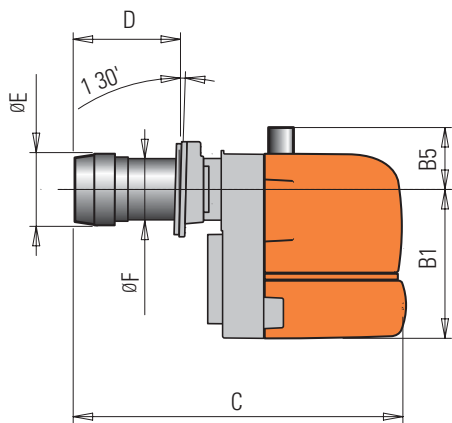
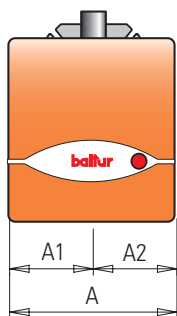

Dimensions

On request BTG 3 burners can be supplied with sliding flange

Model	A mm	A ₁ mm	A ₂ mm	B ₁ mm	B ₅ mm	C mm	D		E mm	F mm	I mm	I ₁ mm	L		M mm	N mm
							min mm	max mm					min mm	max mm		
BTG 3	250	120,0	130,0	170,0	48	330	90		90	90	170	144	135	161	M8	95
BTG 3,6	245	122,5	122,5	218,5	53	410	50	105	90	90	170	144	130	155	M8	95
BTG 6	245	122,5	122,5	218,5	53	410	50	105	90	90	170	140	130	155	M8	95
BTG 11	245	122,5	122,5	218,5	53	475	90	150	108	90	170	140	130	155	M8	95
BTG 3,6 P	245	122,5	122,5	218,5	53	410	50	105	90	90	170	140	130	155	M8	95
BTG 6 P	245	122,5	122,5	218,5	53	410	50	105	90	90	170	140	130	155	M8	95
BTG 11 P	245	122,5	122,5	218,5	53	475	90	150	108	90	170	140	130	155	M8	95

Model	Package dimensions mm			Weights kg
	L	P	H	
BTG 3	400	280	280	9
BTG 3,6	500	300	320	12
BTG 6	500	300	320	12
BTG 11	500	300	320	12
BTG 3,6 P	500	300	320	12
BTG 6 P	500	300	320	12
BTG 11 P	500	300	320	12

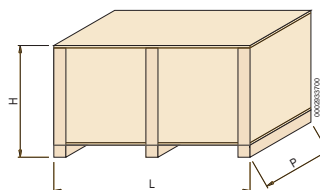

BTG to 16,6 from 99 kW SERIES

PLUS

Excellent value for money

Very compact

Combustion head fully accessible without the need to remove the burner

Sliding flange (excluding BTG 3) for best connection of any type of combustion chamber

Automatically closing air gate

Quiet running

Characteristics

BTG SERIES

TECHNICAL-FUNCTIONAL CHARACTERISTICS

- Gas-fired burner.
- Single stage operation (on/off).
- Ability to operate with any type of combustion chamber.
- Air-gas mixing at blast-pipe.
- Ability to obtain optimal combustion values by regulating combustion air and blast-pipe.
- Maintenance facilitated by the fact that the mixing unit can be removed without having to remove the burner from the boiler.

- Manual air flow adjustment.
- Possibility to choose gas train with valve tightness control.
- Equipped with one 7-pole connector, one flange and one insulating seal for boiler fastening.
- On request: longer blast tube.

CONSTRUCTION CHARACTERISTICS

The burner consists of:

- Light aluminium alloy fan part.
- High performance centrifugal fan.
- Combustion air inlet with device to adjust the air flow; automatically closing air gate.
- Sliding boiler coupling flange to adapt the head protrusion to the various types of boilers (fixed on BTG 3).
- Adjustable combustion head complete with steel blast tube (stainless steel on BTG 11) and deflector disk.
- Monophase electric motor to run fan.
- Air pressure switch to ensure the presence of combustion air.
- Gas train complete with operation and safety valve, minimum pressure switch, pressure regulator and gas filter.
- Automatic control and command equipment for the burner, compliant with European standard EN298.
- Flame detection by ionisation electrode.
- 7-pole outlet for burner electrical and thermostat connections.
- Prepared for microamperometer connection with ionisation cable.
- Electrical protection rating IP40.
- Sound-proof plastic protective cover.

Inside of the burner and combustion head of BTG 3





Characteristics

BTG ..P SERIES

TECHNICAL-FUNCTIONAL CHARACTERISTICS

- Gas burner.
- Two-stage operation (high/low flame).
- Ability to operate with any type of combustion chamber.
- Air-gas mixing at blast-pipe.
- Ability to obtain optimal combustion values by regulating combustion air and blast-pipe.
- Maintenance facilitated by the fact that the mixing unit can be removed without having to remove the burner from the boiler.
- Air flow regulation for first and second stage by means of electric servomotor with pause closure of gate to prevent any heat dispersion to flue.
- Possibility to chose gas train with valve tightness control.
- Equipped with one 4 and 7-pole connector, one flange and one insulating seal for boiler fastening.
- On request: longer blast tube.

CONSTRUCTION CHARACTERISTICS

The burner consists of:

- Light aluminium alloy fan part.
- High performance centrifugal fan.
- Combustion air inlet with device to adjust the air flow; automatically closing air gate
- Sliding boiler coupling flange to adapt the head protrusion to the various types of boilers.
- Adjustable combustion head complete with steel blast tube (stainless steel on BTG 11) and deflector disk.
- Monophase electric motor to run fan.
- Air pressure switch to ensure the presence of combustion air.
- Burner gas/train complete with operation and safety valve, minimum pressure switch, pressure regulator and gas filter.
- Automatic control and command equipment for the burner, compliant with European standard EN298.
- Flame detection by ionisation electrode.
- 7-pole outlet for burner electrical and thermostat connections, and 4-pole

outlet for second stage control.

- Prepared for microamperometer connection with ionisation cable.
- Electrical protection rating IP40.
- Sound-proof plastic protective cover.

Possible air regulation from outside (BTG 3)



Functional diagram

Legend

SINGLE-STAGE BURNERS

- 1 Manual air adjustment switch
- 2 Air pressure switch
- 3 Operating valve
- 4 On request valve tightness control
- 5 Gas pressure regulator
- 6 Safety valve
- 7 Minimum pressure switch
- 8 Gas filter

Carried out by the installing technician.

- 9 Anti-vibration joint
- 10 Ball valve

SINGLE-STAGE BURNERS

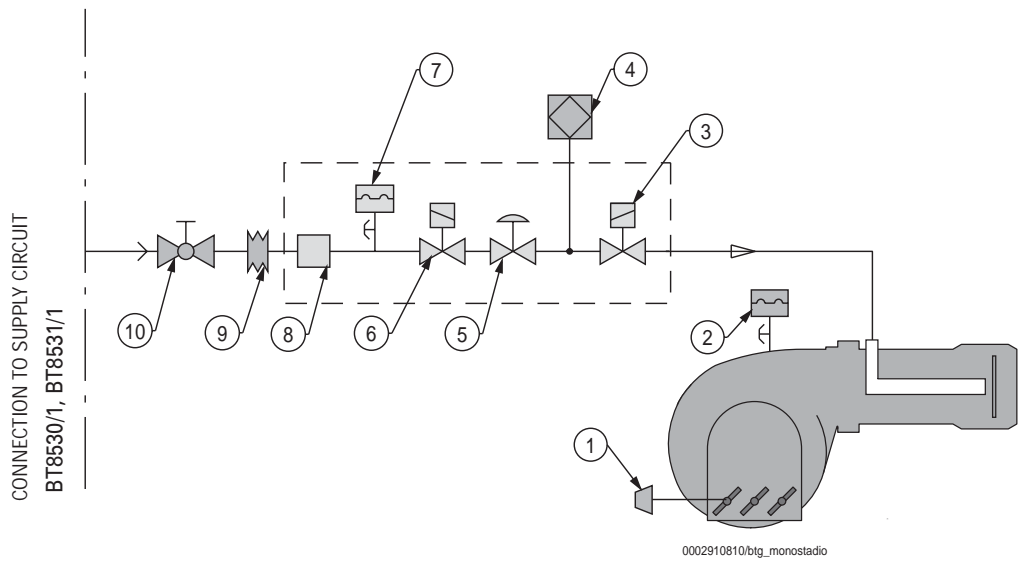

TWO-STAGE BURNERS

Legend

TWO-STAGE BURNERS

- 1 Air adjustment servomotor.
- 2 Air pressure switch
- 3 Two-stage operating valve
- 6 On request valve tightness control
- 7 Minimum pressure switch
- 9 Safety valve
- 10 Gas pressure regulator
- 11 Gas filter

Carried out by the installing technician.

- 12 Anti-vibration joint
- 13 Ball valve

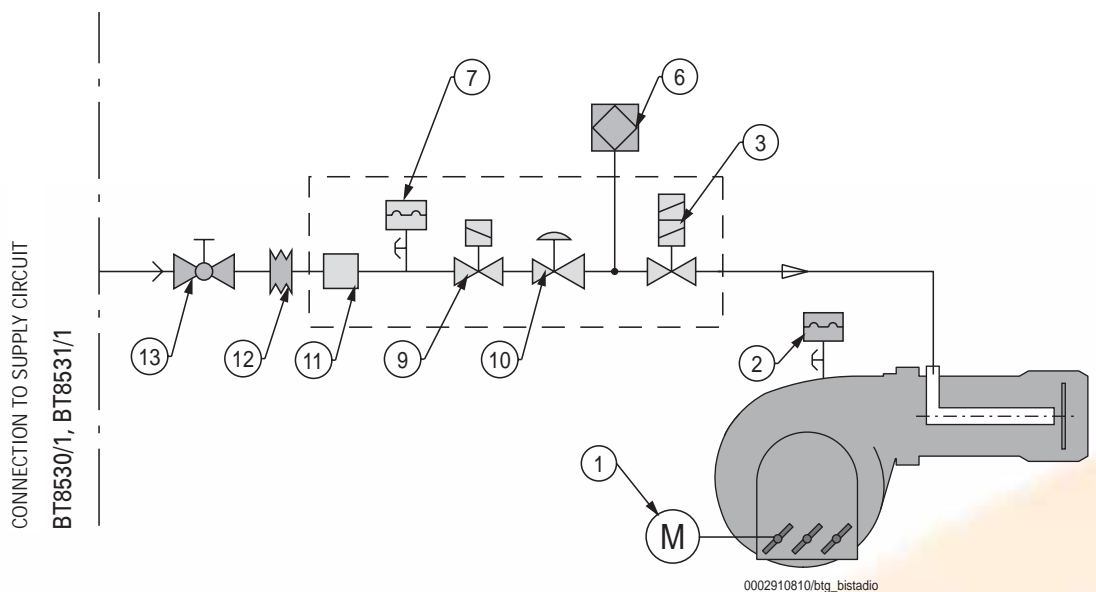
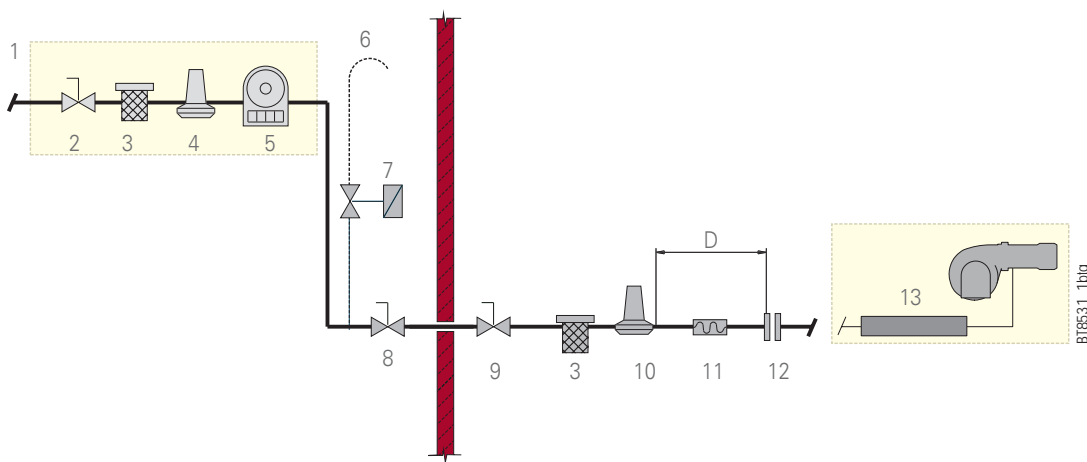

DIAGRAM FOR THE CONNECTION OF A BURNER TO THE GAS MAINS AT AVERAGE PRESSURE (BT 8531/1)



Gas supply connection

- Legend**
- 1 Central reduction and measurement unit.
 - 2 Stop-cock.
 - 3 Gas filter.
 - 4 Pressure reducer.
 - 5 Flow meter.
 - 6 Discharge into the atmosphere with flame trap net.
 - 7 Possible automatic bleed valve (must discharge externally in suitable place).
 - 8 Emergency valve.
 - 9 Ball valve.
 - 10 Reduction unit or pressure regulator/stabiliser (suited to the specific case).
 - 11 Anti-vibration joint.
 - 12 Flange coupling.
 - 13 Gas train.
 - D Distance between stabiliser (or regulator/stabiliser) and gas valve at least 1,5 - 2 m).

DIAGRAM FOR THE CONNECTION OF A BURNER TO THE GAS MAINS AT AVERAGE PRESSURE (BT 8530/1)

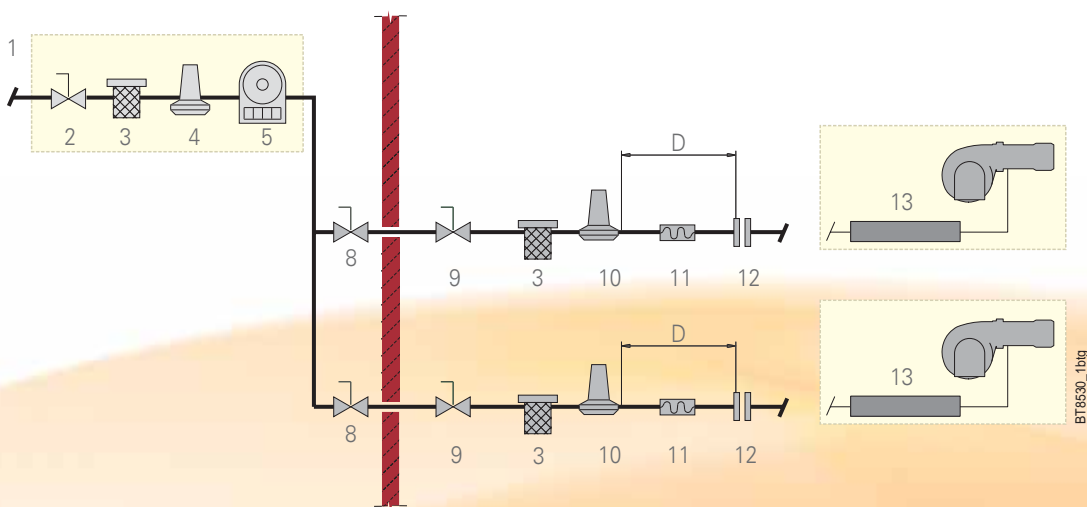



baltur

Baltur S.p.A.

Via Ferrarese, 10
44042 Cento (Fe) - Italy
Tel. +39 051-6843711
Fax: +39 051-6857527/28
www.baltur.it
info@baltur.it

Data reported in this brochure shall be considered as indicative;
Baltur reserves the right to change them without previous notice.